

BORMANN®

Lite Series



BTV1200

025993



v2.2



Rated
45kg/99lbs

VESA
75x75 100x100
200x200 200x200

MOST
26"-55"
TVs

WWW.NIKOLAOUTOOLS.GR

2 YEARS
WARRANTY

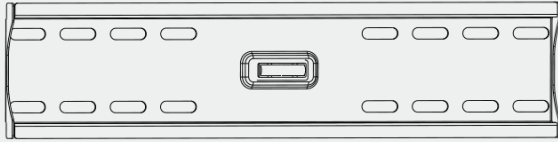

Wall plate (x1)
Επιτοίχια Βάση (x1)

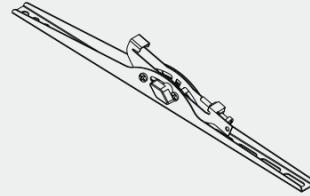

Arm (x2)
Βραχίονας (x2)



ST6.3x55 (x4)
A

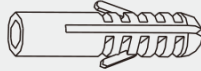

Βύσμα δομικών υλικών (x4)
concrete anchor (x4)
B



Ροδέλα D6(x4)
D6 washer (x4)
C



M4x12 (x4)
D



M5x12 (x4)
E

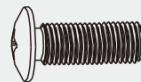

M6x16 (x4)
F

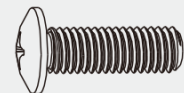

M8x16 (x4)
G



Ροδέλα D5 (x4)
D5 washer (x4)
H



Ροδέλα D8 (x4)
D8 washer (x4)
I



Αποστάτης (x4)
spacer (x4)
J

1a.

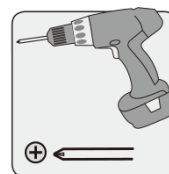
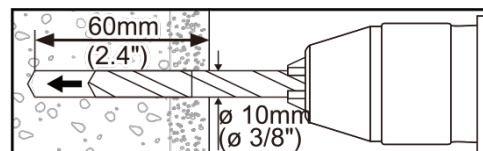
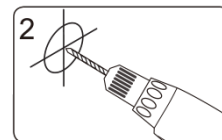
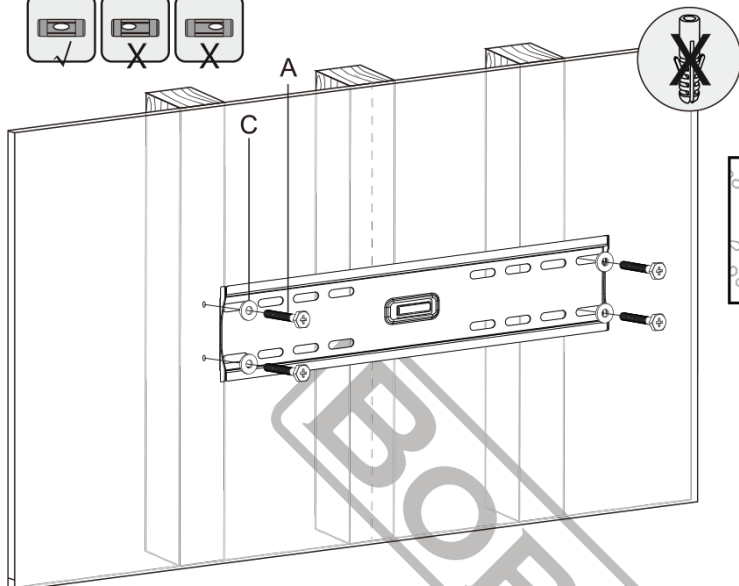
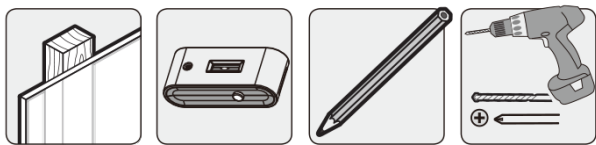

1b.

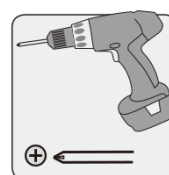
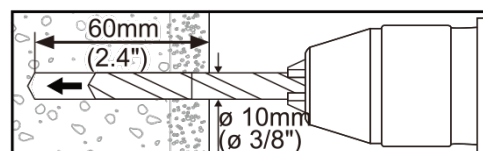
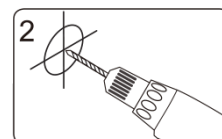
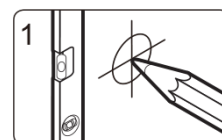
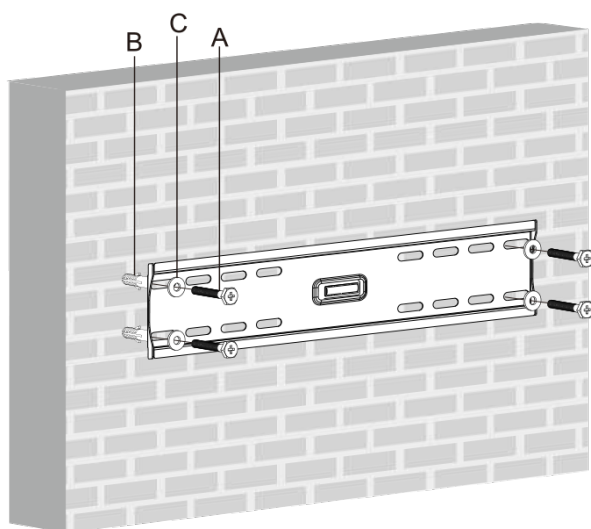
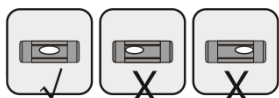
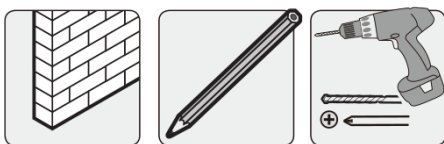

2.

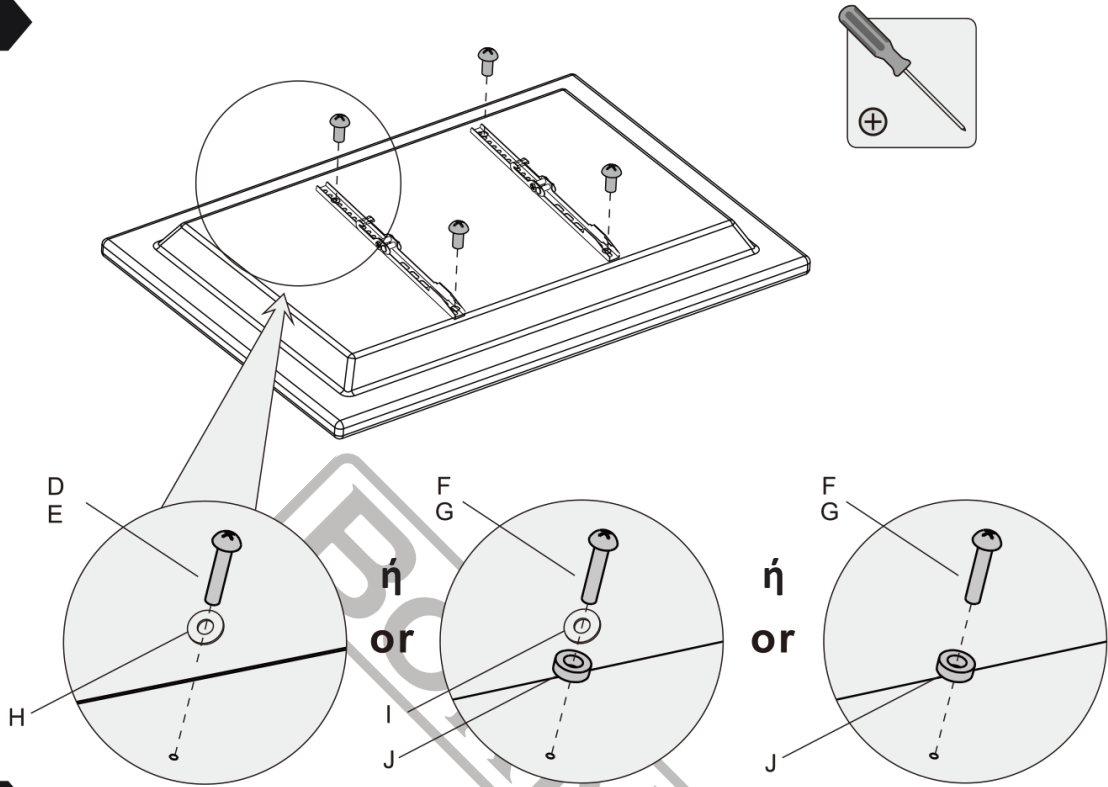

3.

